



FA 60 022 00





MultisafeWay

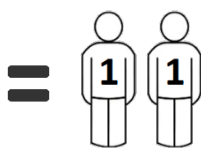
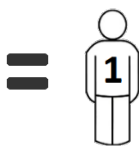
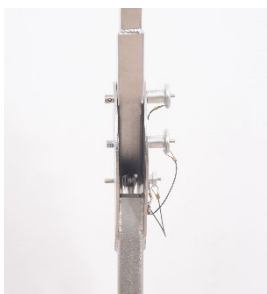
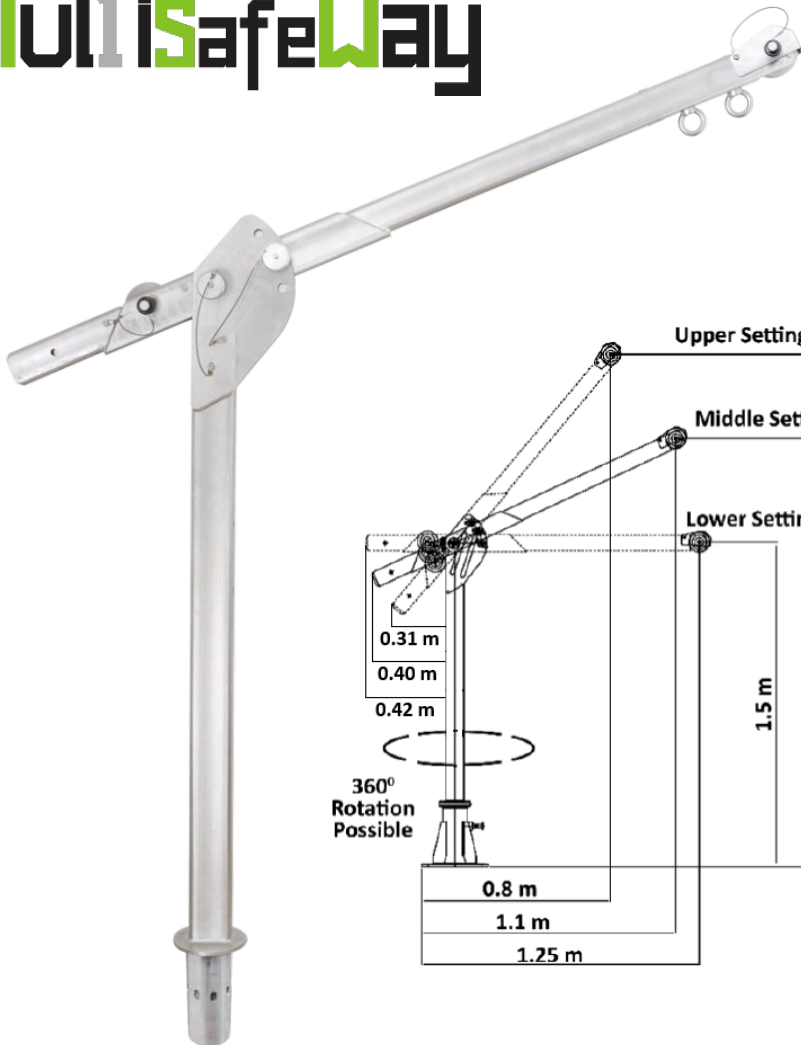

II2 G Exh IIC T6 Gb



HS CODE
84251900
CARTON SIZE / PCS.
158 x 33 x 20 cm / 1
Certificate of test SPC0223656/1414 I3 E1
Satra Technology Centre, N° 0321 Wyndham Way, Telford Way, Kettering Northamptonshire, NN16 8SD, United Kingdom
ACKNOWLEDGEMENT OF RECEIPT N°1120/1/2020
Technická Inšpekcia, a.s. N°1354 Trnavská cesta 56, 821 01 Bratislava, Slovenská Republika

REF.	FA 60 022 00
CE	EN 795:2012 Type A
	x1 / x2
	300 KG
MAT.	
DIM. \updownarrow H	1.50m/1.90m/2.30m
R (kN) / MBS (kN)	15 kN / 16 kN
+	ATEX Zone 1, Machinery Directive 360° Rotation (8 positions) EN 80079-36:2016 EN 80079-37:2016
	34.87 KG (Column = 19.1 KG / Arm = 15.77 KG)



Nombre d'utilisateurs
Number of users
Cantidad de usuarios
Quantità di utilizzatori
Anzahl der Benutzer



Charge maxi admissible
Max. allowable load
Carga máxima admisible
Peso massimale
Zulässige Höchstlast

DIM. \updownarrow H

Hauteur
Height
Altura
Altezza
Höhe